

To all our customers

Regarding the change of names mentioned in the document, such as Mitsubishi Electric and Mitsubishi XX, to Renesas Technology Corp.

The semiconductor operations of Hitachi and Mitsubishi Electric were transferred to Renesas Technology Corporation on April 1st 2003. These operations include microcomputer, logic, analog and discrete devices, and memory chips other than DRAMs (flash memory, SRAMs etc.) Accordingly, although Mitsubishi Electric, Mitsubishi Electric Corporation, Mitsubishi Semiconductors, and other Mitsubishi brand names are mentioned in the document, these names have in fact all been changed to Renesas Technology Corp. Thank you for your understanding. Except for our corporate trademark, logo and corporate statement, no changes whatsoever have been made to the contents of the document, and these changes do not constitute any alteration to the contents of the document itself.

Note : Mitsubishi Electric will continue the business operations of high frequency & optical devices and power devices.

Renesas Technology Corp.
Customer Support Dept.
April 1, 2003

BCR16CM

MEDIUM POWER USE

NON-INSULATED TYPE, PLANAR PASSIVATION TYPE

Refer to the page 6 as to the product guaranteed maximum junction temperature 150°C

BCR16CM



- **IT (RMS)** **16A**
- **VDRM** **600V**
- **IFGT I , IRGT I , IRGT III** **20mA**

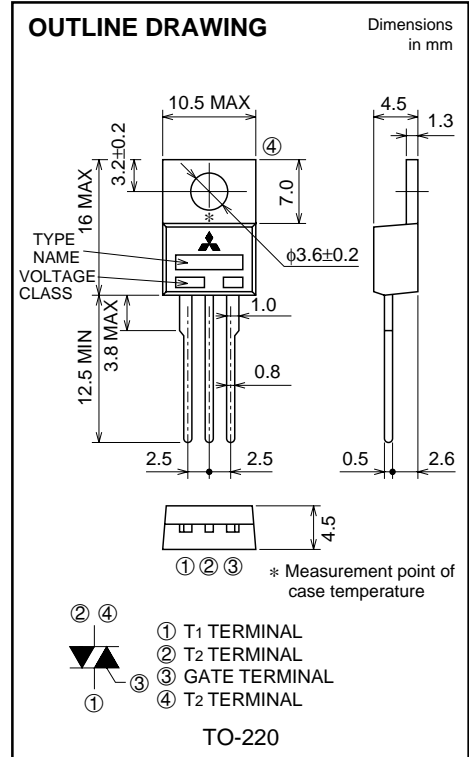

APPLICATION

Contactless AC switches , light dimmer, electric flasher unit, hair drier, control of household equipment such as TV sets · stereo · refrigerator · washing machine · infrared kotatsu · carpet · electric fan, solenoid drivers, small motor control, copying machine, electric tool, other general purpose control applications

MAXIMUM RATINGS

Symbol	Parameter	Voltage class		Unit
		12	600	
VDRM	Repetitive peak off-state voltage *1	600		V
VDSM	Non-repetitive peak off-state voltage *1	720		V

Symbol	Parameter	Conditions	Ratings	Unit
IT (RMS)	RMS on-state current	Commercial frequency, sine full wave 360° conduction, Tc=100°C *3	16	A
ITSM	Surge on-state current	60Hz sinewave 1 full cycle, peak value, non-repetitive	170	A
I ² t	I ² t for fusing	Value corresponding to 1 cycle of half wave 60Hz, surge on-state current	121	A ² s
PGM	Peak gate power dissipation		5.0	W
PG (AV)	Average gate power dissipation		0.5	W
VGM	Peak gate voltage		10	V
IGM	Peak gate current		2	A
Tj	Junction temperature		-40 ~ +125	°C
Tstg	Storage temperature		-40 ~ +125	°C
—	Weight	Typical value	2.0	g

*1. Gate open.

BCR16CM

Refer to the page 6 as to the product guaranteed maximum junction temperature 150°C

MEDIUM POWER USE
NON-INSULATED TYPE, PLANAR PASSIVATION TYPE

ELECTRICAL CHARACTERISTICS

Symbol	Parameter	Test conditions	Limits			Unit	
			Min.	Typ.	Max.		
IDRM	Repetitive peak off-state current	T _j =125°C, V _{DRM} applied	—	—	2.0	mA	
V _{TM}	On-state voltage	T _c =25°C, I _{TM} =25A, Instantaneous measurement	—	—	1.5	V	
V _{FGT I}	Gate trigger voltage *2	T _j =25°C, V _D =6V, R _L =6Ω, R _G =330Ω	I	—	—	1.5	V
V _{RGT I}			II	—	—	1.5	V
V _{RGT III}			III	—	—	1.5	V
I _{FGT I}	Gate trigger current *2	T _j =25°C, V _D =6V, R _L =6Ω, R _G =330Ω	I	—	—	20	mA
I _{RGT I}			II	—	—	20	mA
I _{RGT III}			III	—	—	20	mA
V _{GD}	Gate non-trigger voltage	T _j =125°C, V _D =1/2V _{DRM}	0.2	—	—	V	
R _{th (j-c)}	Thermal resistance	Junction to case *3 *4	—	—	1.4	°C/W	
(dv/dt) _c	Critical-rate of rise of off-state commutating voltage *5	T _j =125°C	10	—	—	V/μs	

*2. Measurement using the gate trigger characteristics measurement circuit.
 *3. Case temperature is measured at the T2 terminal 1.5mm away from the molded case.
 *4. The contact thermal resistance R_{th (c-f)} in case of greasing is 1.0°C/W.
 *5. Test conditions of the critical-rate of rise of off-state commutating voltage is shown in the table below.

Test conditions	Commutating voltage and current waveforms (inductive load)
1. Junction temperature T _j =125°C 2. Rate of decay of on-state commutating current (di/dt) _c =-8.0A/ms 3. Peak off-state voltage V _D =400V	

PERFORMANCE CURVES

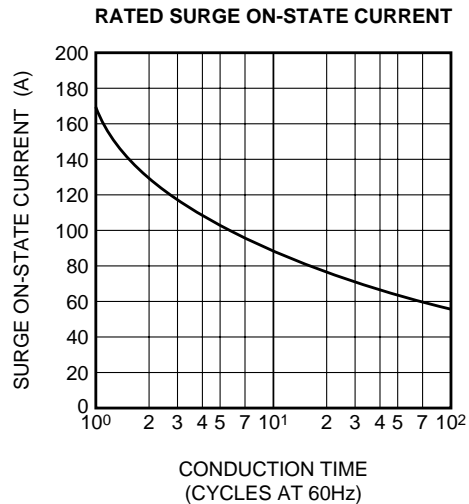
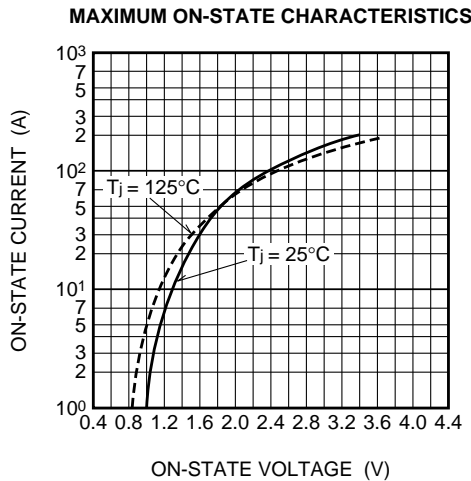

BCR16CM

Refer to the page 6 as to the product guaranteed maximum junction temperature 150°C

MEDIUM POWER USE
NON-INSULATED TYPE, PLANAR PASSIVATION TYPE

GATE CHARACTERISTICS (I, II AND III)

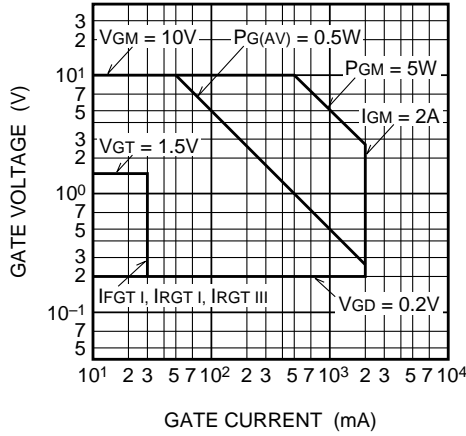

GATE TRIGGER CURRENT VS. JUNCTION TEMPERATURE

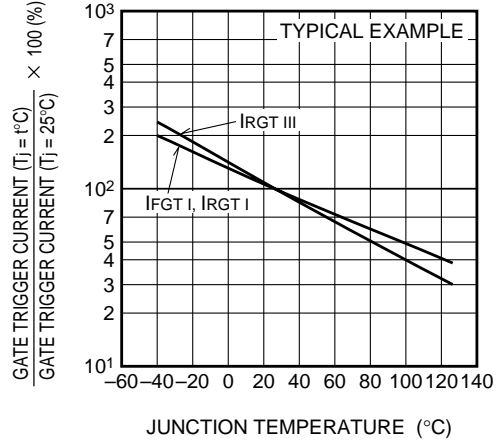

GATE TRIGGER VOLTAGE VS. JUNCTION TEMPERATURE

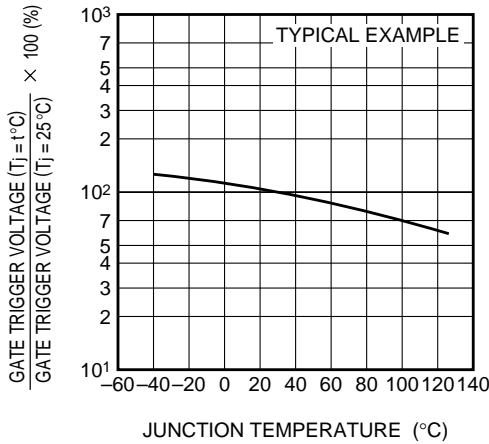

MAXIMUM TRANSIENT THERMAL IMPEDANCE CHARACTERISTICS (JUNCTION TO CASE)

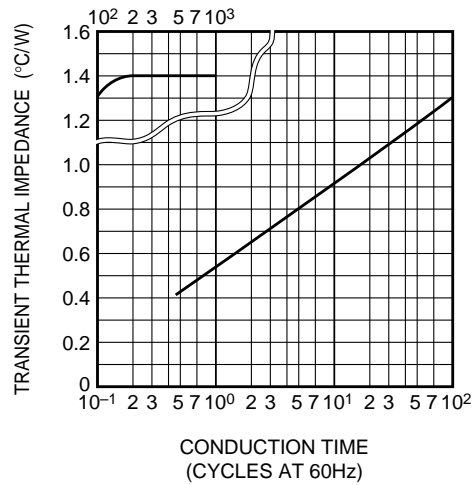

MAXIMUM ON-STATE POWER DISSIPATION

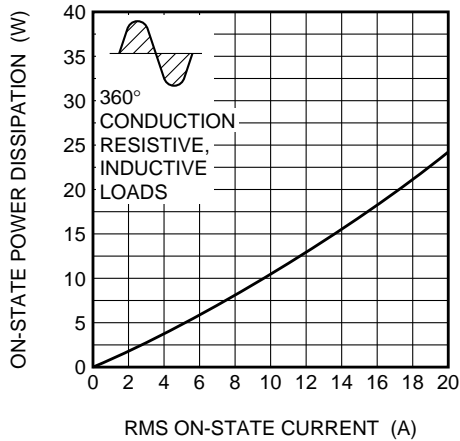

ALLOWABLE CASE TEMPERATURE VS. RMS ON-STATE CURRENT

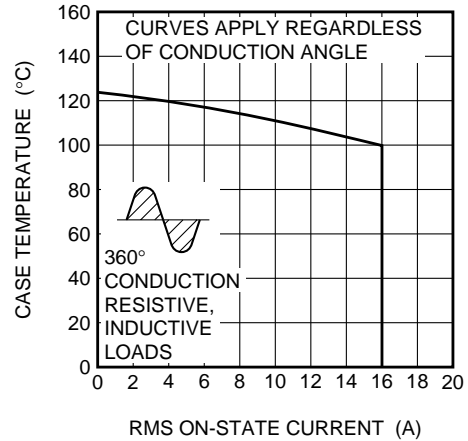

BCR16CM

Refer to the page 6 as to the product guaranteed maximum junction temperature 150°C

MEDIUM POWER USE
NON-INSULATED TYPE, PLANAR PASSIVATION TYPE

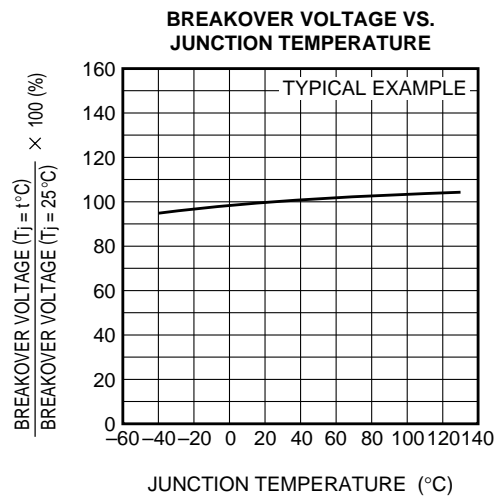
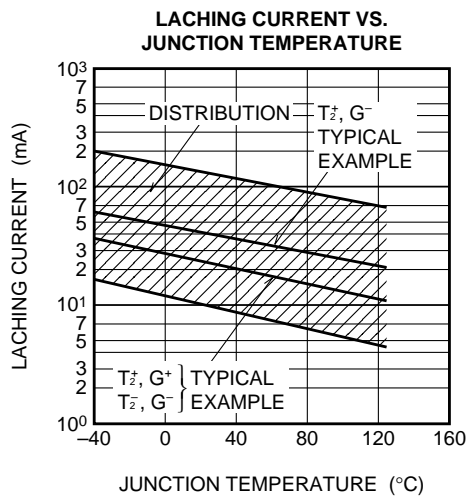
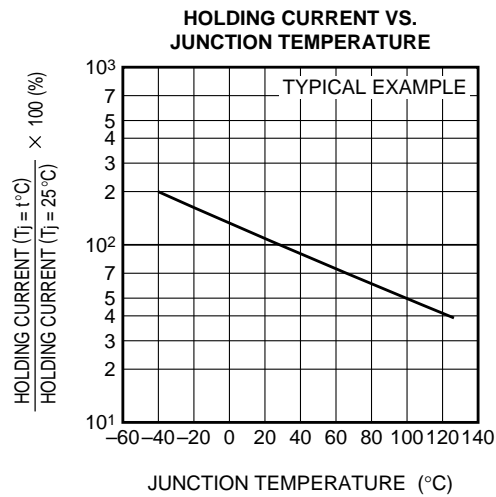
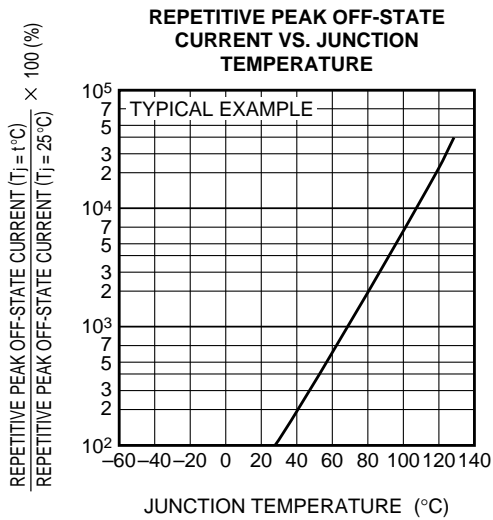
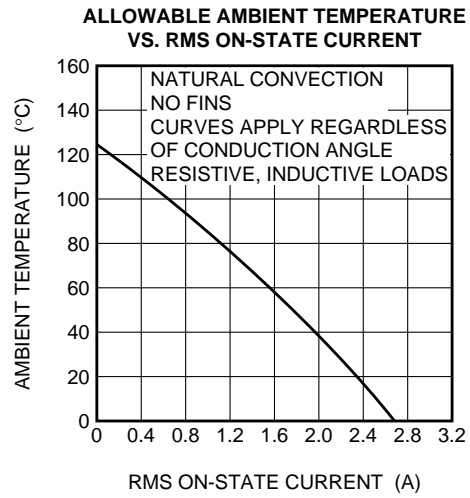
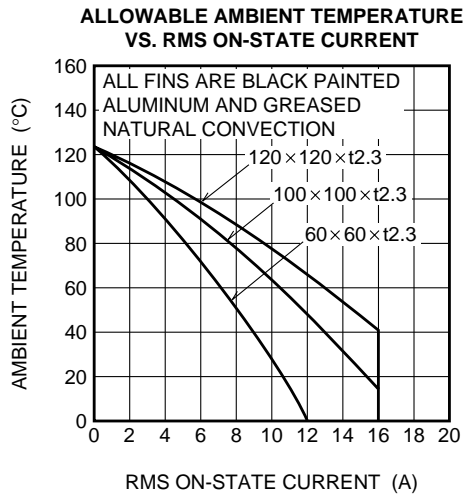

BCR16CM

Refer to the page 6 as to the product guaranteed maximum junction temperature 150°C

MEDIUM POWER USE
NON-INSULATED TYPE, PLANAR PASSIVATION TYPE

BREAKOVER VOLTAGE VS. RATE OF RISE OF OFF-STATE VOLTAGE

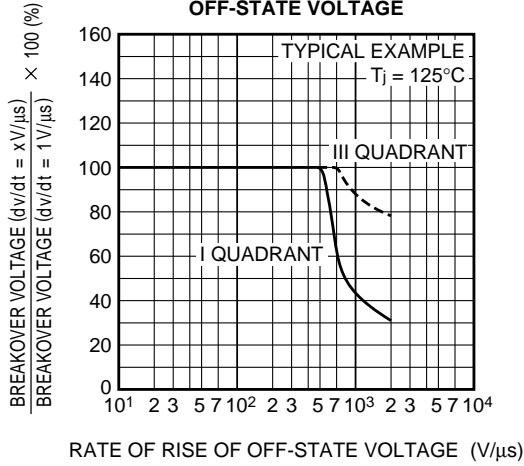

COMMUTATION CHARACTERISTICS

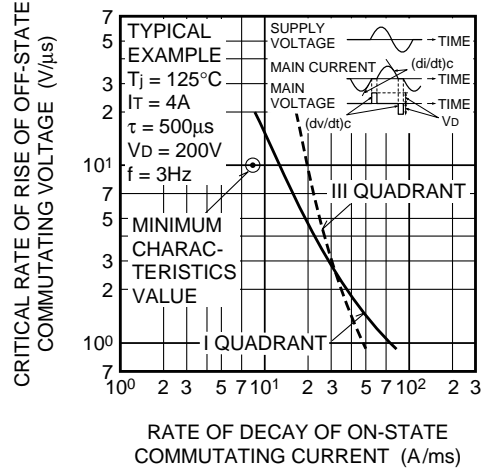

GATE TRIGGER CURRENT VS. GATE CURRENT PULSE WIDTH

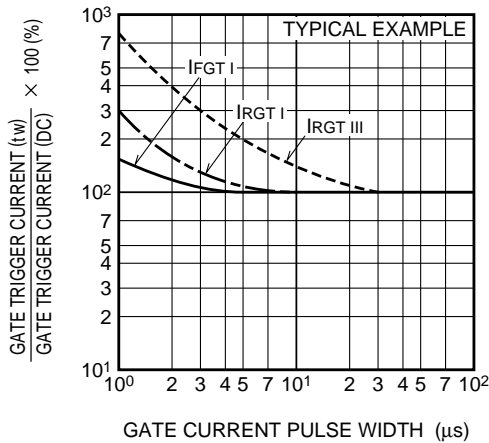

GATE TRIGGER CHARACTERISTICS TEST CIRCUITS

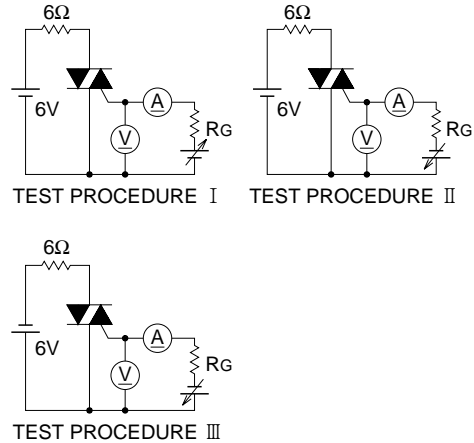

BCR16CM

MEDIUM POWER USE

NON-INSULATED TYPE, PLANAR PASSIVATION TYPE

The product guaranteed maximum junction temperature 150°C (See warning.)

BCR16CM



- **IT (RMS)** **16A**
- **VDRM** **600V**
- **IFGT I , IRGT I , IRGT III** **20mA**

OUTLINE DRAWING Dimensions in mm

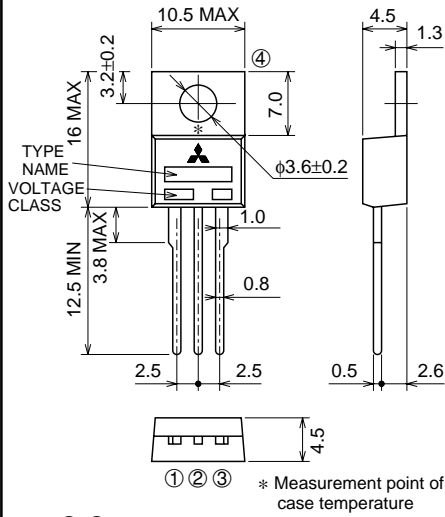

TYPE NAME
VOLTAGE CLASS

① ② ③ * Measurement point of case temperature

① T1 TERMINAL
② T2 TERMINAL
③ GATE TERMINAL
④ T2 TERMINAL

TO-220

APPLICATION

Contactless AC switches , light dimmer, electric flasher unit, hair drier, control of household equipment such as TV sets · stereo · refrigerator · washing machine · infrared kotatsu · carpet · electric fan, solenoid drivers, small motor control, copying machine, electric tool, other general purpose control applications

(Warning)

1. Refer to the recommended circuit values around the triac before using.
2. Be sure to exchange the specification before using. If not exchanged, general triacs will be supplied.

MAXIMUM RATINGS

Symbol	Parameter	Voltage class		Unit
		12	600	
VDRM	Repetitive peak off-state voltage *1	600		V
VDSM	Non-repetitive peak off-state voltage *1	720		V

Symbol	Parameter	Conditions	Ratings	Unit
IT (RMS)	RMS on-state current	Commercial frequency, sine full wave 360° conduction, Tc=125°C *3	16	A
ITSM	Surge on-state current	60Hz sinewave 1 full cycle, peak value, non-repetitive	170	A
I ² t	I ² t for fusing	Value corresponding to 1 cycle of half wave 60Hz, surge on-state current	121	A ² s
PGM	Peak gate power dissipation		5.0	W
PG (AV)	Average gate power dissipation		0.5	W
VGM	Peak gate voltage		10	V
IGM	Peak gate current		2	A
Tj	Junction temperature		-40 ~ +150	°C
Tstg	Storage temperature		-40 ~ +150	°C
—	Weight	Typical value	2.0	g

*1. Gate open.

BCR16CM

The product guaranteed maximum junction temperature 150°C (See warning.)

MEDIUM POWER USE
NON-INSULATED TYPE, PLANAR PASSIVATION TYPE

ELECTRICAL CHARACTERISTICS

Symbol	Parameter	Test conditions	Limits			Unit	
			Min.	Typ.	Max.		
IDRM	Repetitive peak off-state current	T _j =150°C, V _{DRM} applied	—	—	2.0	mA	
VTM	On-state voltage	T _c =25°C, I _{TM} =25A, Instantaneous measurement	—	—	1.5	V	
VFGT I	Gate trigger voltage *2	T _j =25°C, V _D =6V, R _L =6Ω, R _G =330Ω	I	—	—	1.5	V
VRGT I			II	—	—	1.5	V
VRGT III			III	—	—	1.5	V
IFGT I	Gate trigger current *2	T _j =25°C, V _D =6V, R _L =6Ω, R _G =330Ω	I	—	—	20	mA
IRGT I			II	—	—	20	mA
IRGT III			III	—	—	20	mA
VGD	Gate non-trigger voltage	T _j =125°C/150°C, V _D =1/2V _{DRM}	0.2/0.1	—	—	V	
Rth (j-c)	Thermal resistance	Junction to case *3 *4	—	—	1.4	°C/W	
(dv/dt) _c	Critical-rate of rise of off-state commutating voltage *5	T _j =125°C/150°C	10/1	—	—	V/μs	

*2. Measurement using the gate trigger characteristics measurement circuit.

*3. Case temperature is measured at the T2 terminal 1.5mm away from the molded case.

*4. The contact thermal resistance Rth (c-f) in case of greasing is 1.0°C/W.

*5. Test conditions of the critical-rate of rise of off-state commutating voltage is shown in the table below.

Test conditions	Commutating voltage and current waveforms (inductive load)
1. Junction temperature T _j =125°C/150°C 2. Rate of decay of on-state commutating current (di/dt) _c =-8.0A/ms 3. Peak off-state voltage V _D =400V	

PERFORMANCE CURVES

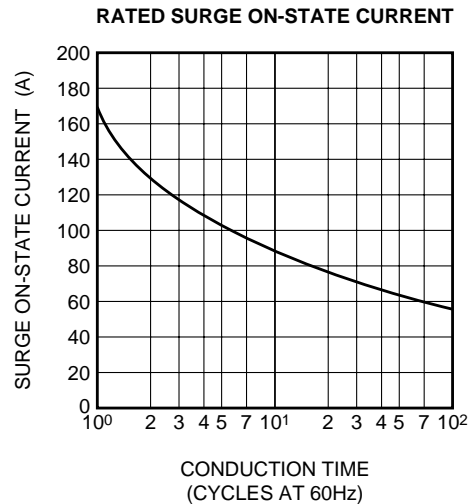
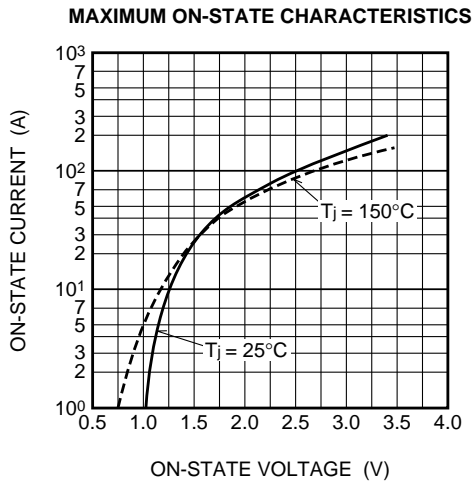

BCR16CM

The product guaranteed maximum junction temperature 150°C (See warning.)

MEDIUM POWER USE
NON-INSULATED TYPE, PLANAR PASSIVATION TYPE

**GATE CHARACTERISTICS
(I, II AND III)**

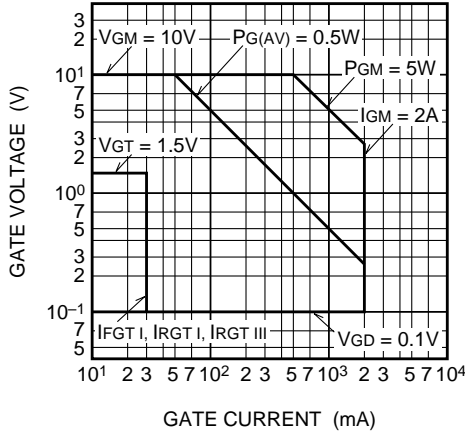

**GATE TRIGGER CURRENT VS.
JUNCTION TEMPERATURE**

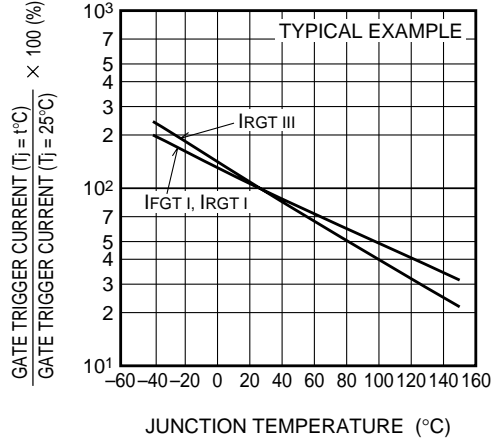

**GATE TRIGGER VOLTAGE VS.
JUNCTION TEMPERATURE**

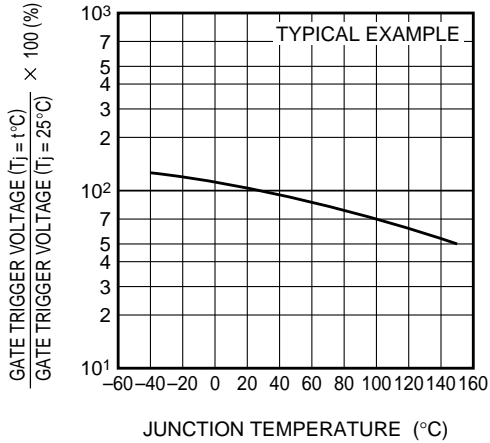

**MAXIMUM TRANSIENT THERMAL
IMPEDANCE CHARACTERISTICS
(JUNCTION TO CASE)**

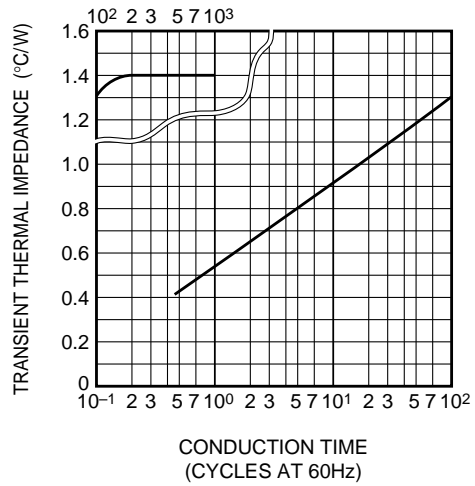

**MAXIMUM ON-STATE POWER
DISSIPATION**

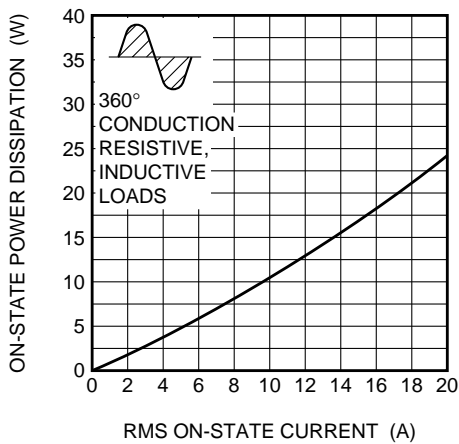

**ALLOWABLE CASE TEMPERATURE
VS. RMS ON-STATE CURRENT**

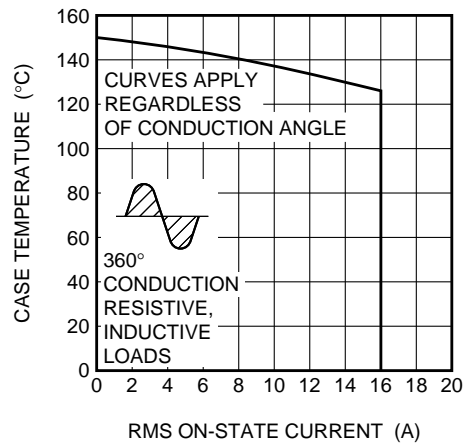

BCR16CM

The product guaranteed maximum junction temperature 150°C (See warning.)

MEDIUM POWER USE
NON-INSULATED TYPE, PLANAR PASSIVATION TYPE

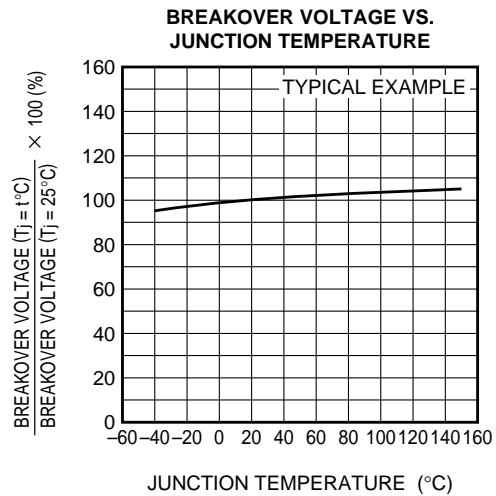
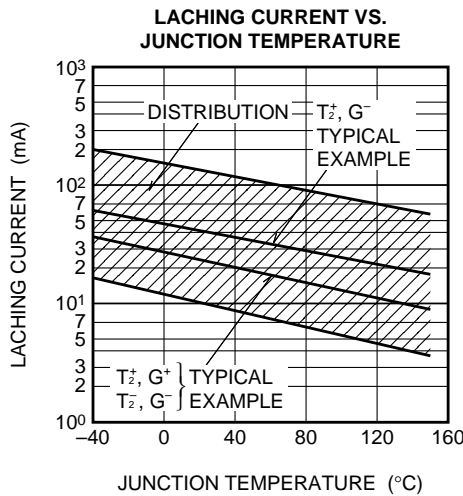
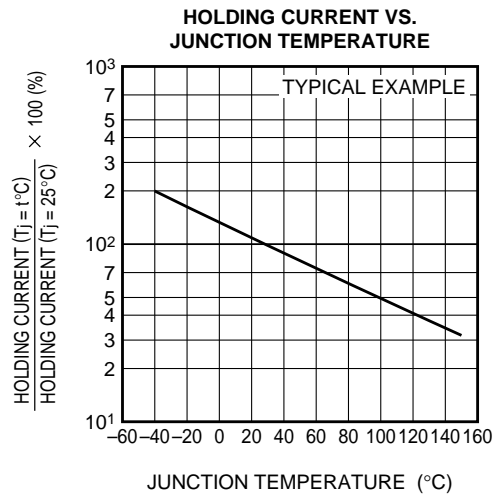
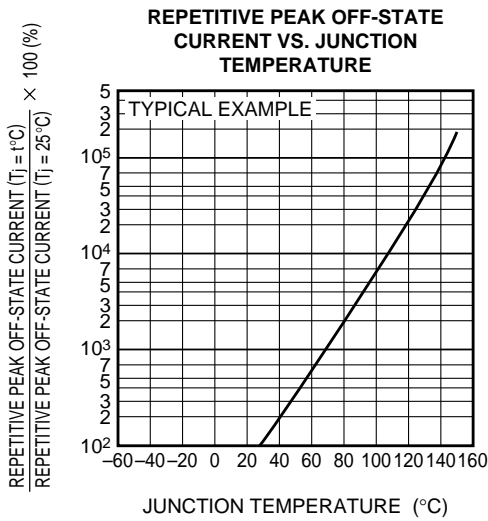
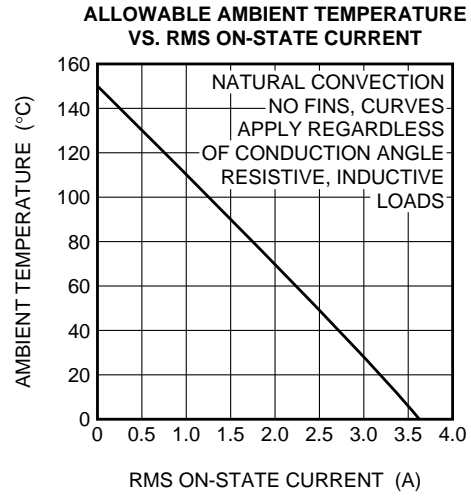
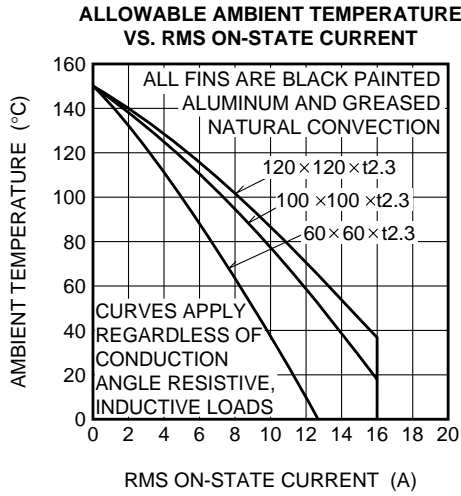

BCR16CM

The product guaranteed maximum junction temperature 150°C (See warning.)

MEDIUM POWER USE
NON-INSULATED TYPE, PLANAR PASSIVATION TYPE

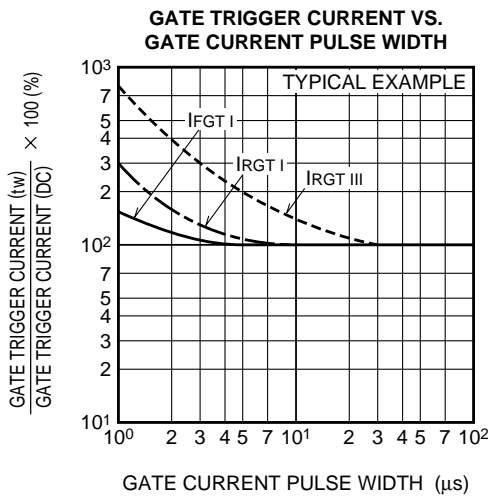
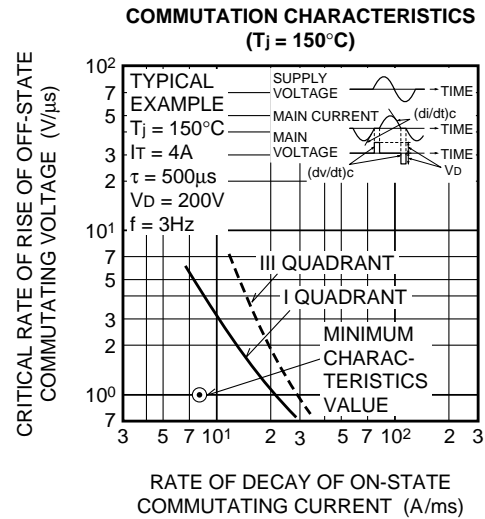
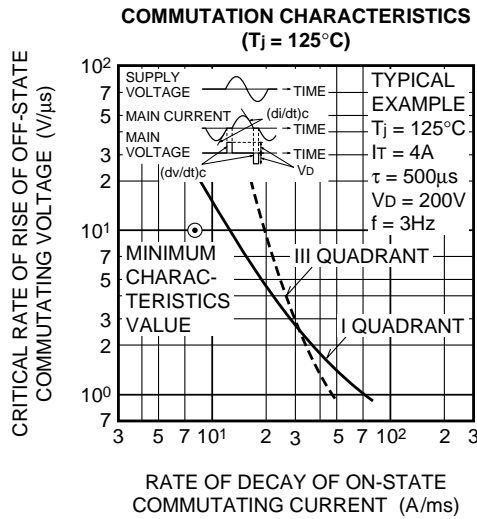
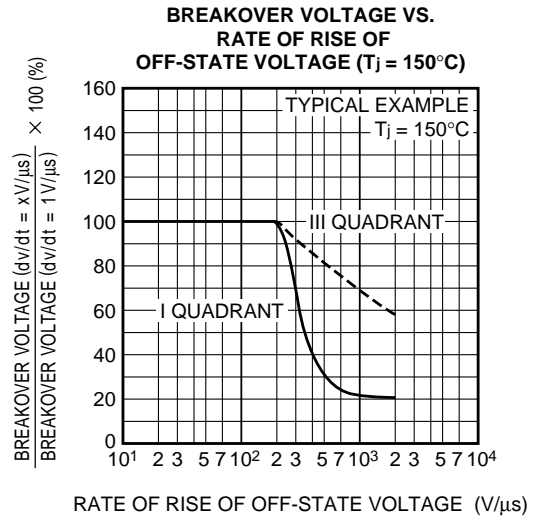
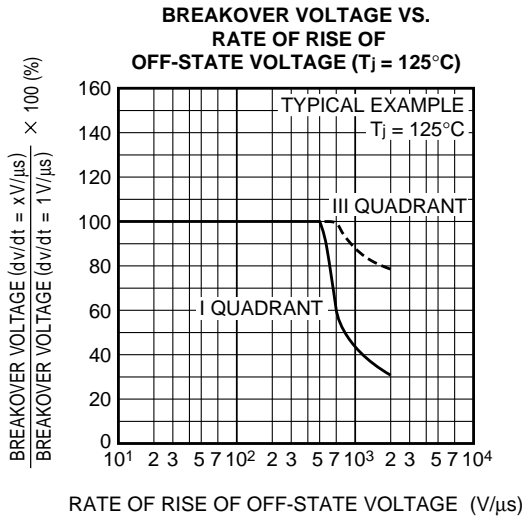

BCR16CM

The product guaranteed maximum junction temperature 150°C (See warning.)

MEDIUM POWER USE
NON-INSULATED TYPE, PLANAR PASSIVATION TYPE

GATE TRIGGER CHARACTERISTICS TEST CIRCUITS

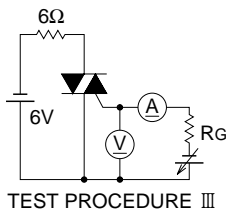
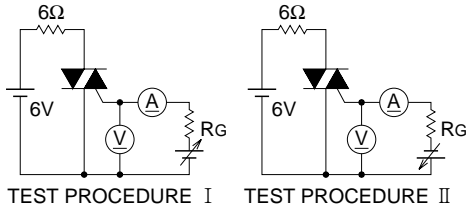

RECOMMENDED CIRCUIT VALUES AROUND THE TRIAC

